

## Combination Sidewalk Bolts

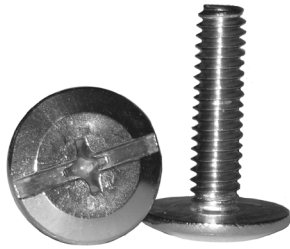

- U.S. Letters Patent
  - No. 6,328,517 (Combination Drive)
  - No. 6,481,944 (Phillips)
  - No. 6,682,283 (Square & Other Drives)
- Combination Phillips / Slot Drive - use with #3 Phillips Bit.

Application: Use either a #3 Phillips bit or a slotted bit to install into a 1/4-20 anchor, bushing, or other insert.

ITEM NO.	SIZE / MATERIAL
25C50MCSS	1/4-20 X 1/2" 18-8 SS
25C75MCSS	1/4-20 X 3/4" 18-8 SS
25C100MCSS	1/4-20 X 1" 18-8 SS
25C125MCSS	1/4-20 X 1-1/4" 18-8 SS
25C150MCSS	1/4-20 X 1-1/2" 18-8 SS
25C200MCSS	1/4-20 X 2" 18-8 SS
25C250MCSS	1/4-20 X 2-1/2" 18-8 SS
25C300MCSS	1/4-20 X 3" 18-8 SS
25C350MCSS	1/4-20 X 3-1/2" 18-8 SS
25C400MCSS	1/4-20 X 4" 18-8 SS
25C500MCSS	1/4-20 X 5" 18-8 SS
25C600MCSS	1/4-20 X 6" 18-8 SS

## Large Diameter Sidewalk Bolts



ITEM NO.	SIZE / MATERIAL
37C75MWSS	3/8-16 X 3/4" 18-8 SS
37C100MWSS	3/8-16 X 1" 18-8 SS
37C150MWSS	3/8-16 X 1-1/2" 18-8 SS
37C200MWSS	3/8-16 X 2" 18-8 SS
50C75MWSS	1/2-13 X 3/4" 18-8 SS
50C100MWSS	1/2-13 X 1" 18-8 SS
50C125MWSS	1/2-13 X 1-1/4" 18-8 SS
50C150MWSS	1/2-13 X 1-1/2" 18-8 SS

*Our Trucks Deliver Throughout SE & SW Florida*

To Place an Order Please Call Customer Service at 1-800-226-5555 or Fax to 800-582-6110

## All Points Solid Set Machine Screw Anchors



• Miami-Dade County Product Control Approved  
- NOA No. 05-1116.04

**Application:** Use in concrete or concrete block. All Points solid set anchors have published values for your engineering needs. Use with 1/4-20 Combo Sidewalk Bolt, Truss Combo Machine Screw, or other machine bolts.



ITEM NO.	SIZE / MATERIAL
25CAMSZ/AP	1/4-20 SOLID SET MACHINE SCREW ANCHOR

ALLOWABLE LOADS (LBS.)													
CONCRETE (fc=3000 PSI MIN.)							CMU (fm=1800PSI MIN.)						
MIN. EMBED.	EDGE DISTANCE						MIN. EMBED.	EDGE DISTANCE					
	1-1/4"		2"		3"			1-1/4"		2"		3"	
	TENSION	SHEAR	TENSION	SHEAR	TENSION	SHEAR		TENSION	SHEAR	TENSION	SHEAR	TENSION	SHEAR
7/8"	328	187	428	429	544	565	7/8"	208	153	358	249	395	397



**Combo Sidewalk Bolt & All Points Solid Set Anchor**  
**"A Winning Combination"**

## Other Machine Screw Anchors



Please see our anchor section for a more complete listing of Machine Screw Anchors

ITEM NO.	SIZE / MATERIAL
25CAMSB	1/4-20 MACHINE SCREW ANCHOR - BRASS INSERT
25CAMSZ/R	1/4-20 MACHINE SCREW ANCHOR - POWERS CALK-IN

*Our Trucks Deliver Throughout SE & SW Florida*

To Place an Order Please Call Customer Service at 1-800-226-5555 or Fax to 800-582-6110

We carry an extensive line of Hurricane Hardware. If you need an item and don't see it in our catalog, we would be happy to find it for you. **Special orders are never a problem at All Points!**

## Combo Drill Bits

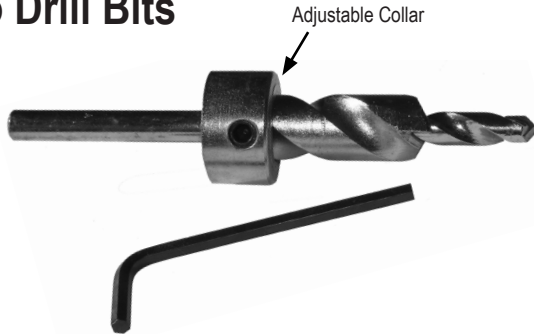

• Replacement pilot bits available.

**Application:** Helps to drill perfect holes for 1/4-20 Machine Screw Anchor. Available in domestic and import varieties. The import is a more economical option.

ITEM NO.	SIZE / MATERIAL
/50NDBC/DOM	1/4" X 1/2" X 2" - DOMESTIC
/50NDBC/IMP	1/4" X 1/2" X 2" - ECONOMY
/50N250DBC	1/4" X 1/2" X 2-1/2" - DOMESTIC OR ECONOMY
/50N300DBC/DOM/WO/C	1/4" X 1/2" X 3" - NO COLLAR-DOMESTIC (STUCCO)
18R325CDBSSS	3/16 X 3 1/4" PILOT BIT FOR SAMMYS
18R400CDBSSS	3/16 X 4" PILOT BIT FOR SAMMYS
18R600CDBSSS	3/16 X 6" PILOT BIT FOR SAMMYS
50NBDC300/37	BASE FOR SAMMYS COMBO BIT

## Setting Tools for Machine Screw Anchors



Hollow Wall Setting Tool

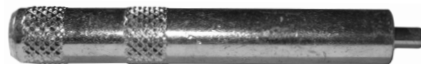

Manual Setting Tool



Manual Heavy Duty Setting Tool



Elco Power Setting Tool

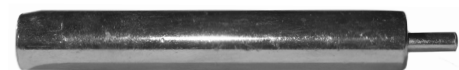

Manual Setting Tool 1/4 x 6"

**Application:** The manual setting tool is used with a hammer and sets the 1/4-20 Machine Screw Anchor by forcing the lead shield over the zinc inser. The power setting tool by Elco™ attaches directly to the drill and acts to pull the insert into the lead shield.

ITEM NO.	SIZE / MATERIAL
/25R600ST	1/4 X 6" MANUAL SETTING TOOL
/25ST	1/4" - MANUAL SETTING TOOL
/25STKS	1/4" - MANUAL SETTING TOOL, HEAVY DUTY
/25HWST	HOLLOW WALL SETTING TOOL, BY GREENLEE
/25STPE	1/4" POWER SETTING TOOL BY ELCO
/25STEZB800	ELCO POWER SETTING TOOL-SHORT
/25STPE/KIT	REPAIR KIT FOR POWER SETTING TOOL
/25STPE/KIT/SM	REPAIR KIT FOR POWER SETTING TOOL - SMALL

*Our Trucks Deliver Throughout SE & SW Florida*

To Place an Order Please Call Customer Service at 1-800-226-5555 or Fax to 800-582-6110

## Washed Wingnuts



- Zamac diecast, nickel plated, heavy duty version.

**Application:** This is a heavy-duty version of the industry standard wingnut. If you compare the All Points' wingnut to others, you will see "Not all wingnuts are created equal". The washed wingnut is used to affix hurricane panels.

ITEM NO.	SIZE / MATERIAL
25CNWW/HD	1/4-20 WASHED WINGNUT, HEAVY DUTY, NICKEL PLATED
25CNWW/HD/LF	1/4-20 X 1-1/8" WASHED WINGNUT, HEAVY DUTY LARGE FLANGE, NICKEL PLATED

## Wingnut Drivers



**Application:** Power Driver attaches to power drill for quick installation of 1/4-20 Washed Wingnuts. Hand Wingnut Driver is available printed with your company name and phone numbers.

ITEM NO.	SIZE / MATERIAL
/PWD	POWER WINGNUT DRIVER
/HWD	HAND WINGNUT DRIVER

## Brass Wood Bushings



- Slotted for easy installation.

**Application:** Use in wood applications. Accepts 1/4-20 bolt. Drill a maximum 3/8" pilot hole. Easily install with a slotted screw driver or brass wood bushing tool. Testing data available upon request.

ITEM NO.	SIZE / MATERIAL
25CWBB/SL	1/4-20 X 5/8" SLOTTED BRASS WOOD BUSHING

## Brass Wood Bushing Tools



**Application:** Installs the 1/4-20 Brass Wood Bushings.

ITEM NO.	SIZE / MATERIAL
/25C600WBT	1/4-20 X 6" HAND WOOD BUSHING TOOL
/25C600WBTH	1/4-20 X 6" POWER WOOD BUSHING TOOL

*Our Trucks Deliver Throughout SE & SW Florida*

To Place an Order Please Call Customer Service at 1-800-226-5555 or Fax to 800-582-6110

We carry an extensive line of Hurricane Hardware. If you need an item and don't see it in our catalog, we would be happy to find it for you. *Special orders are never a problem at All Points!*

## Hurricane Track Hardware

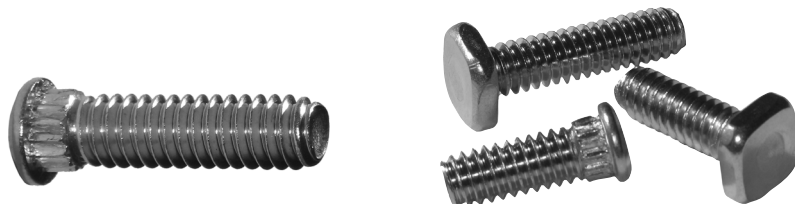

**Application:** The square head fits perfectly into most hurricane panel tracks. The hex head is a less expensive alternative to the square track bolt. The knurled studs are used in the studded angle tracks.

ITEM NO.	SIZE / MATERIAL
/25C75TRACKS	1/4-20 X 3/4" TRACKBOLT 18-8 SS
/25C100TRACKS	1/4-20 X 1" TRACKBOLT 18-8 SS
/25C75HCSS	1/4-20 X 3/4" HEX CAP SCREW, AVAILABLE IN 18-8 SS OR STEEL ZINC PLATED
/25C75SKS	1/4-20 X 3/4" KNURLED STUD 18-8 SS
/25C100SKS	1/4-20 X 1" KNURLED STUD 18-8 SS

## Dycast Wood Insert



**Application:** For use in wood applications with a 1/4-20 bolt. Pronged exterior provides excellent holding power.

ITEM NO.	SIZE / DESCRIPTION
/25CNTSA	1/4-20 DYCAST WOOD INSERT

## Bullet and Clip



• Solid brass, chrome plated.

**Application:** For use with colonial shutters to hold the shutters in an open position. Material is chrome plated over brass and is rust resistant.

ITEM NO.	SIZE / DESCRIPTION
/BULLET/CLIP	CHROME PLATED OVER BRASS
/BULLET/CLIPSM	CHROME PLATED OVER BRASS SMALLER PROFILE CLIP

*Our Trucks Deliver Throughout SE & SW Florida*

To Place an Order Please Call Customer Service at 1-800-226-5555 or Fax to 800-582-6110

## Common Nylon Bushings



- Most of our bushings contain UV protection and are made from virgin nylon.
- HV bushings are exclusively for ASSA members.

When ordering, please specify the number 1 for white or 2 for black.

ITEM NO.	SIZE DESCRIPTION	SCREW SIZE	WHEEL CARRIAGE SIZE	MATERIALS / COLORS
3NBUSNHA10	#3 BUSHING HAT	#10	#10	NYLON-WHITE, BLACK
3NBUSN1HA14	#3 BUSHING HAT	#14	#14	NYLON-WHITE, BLACK
37N43BUSN	3/8 X 7/16"	#10	#10	NYLON-WHITE, BLACK
37N62BUSN	3/8 X 5/8"	#10	#10	RECESSED NYLON-WHITE, BLACK
37N62BUSNR1	3/8 X 5/8"	#10	#10	NYLON-WHITE, NO RECESS
37N75BUSN1	3/8 X 3/4"	#10	#10	MED BUSHING FOR CENTERFOLD SYSTEM
37N87BUSN	3/8 X 7/8"	#10	#10	NYLON-WHITE, BLACK
37N87BUSN/REC	3/8 X 7/8"	#10	#10	RECESSED-WHITE, BLACK
50N50BUSN	1/2 X 1/2"	#14	#14	NYLON-WHITE, BLACK
50N62BUSN	1/2 X 5/8"	#14	#14	NYLON-WHITE, BLACK
50N75BUSN	1/2 X 3/4"	#14	#14	NYLON-WHITE, BLACK
50N87BUSN	1/2 X 7/8"	#14	#14	NYLON-WHITE, BLACK
50N100BUSN/REC	1/2 X 1"	#14	#14	RECESSED-WHITE, BLACK
56N25BUSN	9/16 X 1/4"	#10	#10	NYLON-WHITE, BLACK
50N50ZRSA	1/2 X 1/2"	N/A	N/A	ALUMINUM SPACER
50N75ZRSA	1/2 X 3/4"	N/A	N/A	ALUMINUM SPACER
50N100BUSN/REC	1/2 X 1"	#14	#10	RECESSED-WHITE, BLACK
/ASP-MEDIUM	7/16 X 5/8"	#14	#10	NYLON-WHITE, BLACK
/ASP-HAT	5/16 X 7/16"	#14	#10	NYLON-WHITE, BLACK
/CA-HAT	5/16 X 7/16"	#14	#10	NYLON-WHITE, BLACK
/CA-MEDIUM	29/64 X 37/64"	#14	#10	NYLON-WHITE, BLACK
/CA-LONG	29/64 X 1"	#14	#10	NYLON-WHITE, BLACK
/HVLONG	#10 HIGH VELOCITY	#14	#10	NYLON-WHITE, BLACK
/HVSHORT	#10 HIGH VELOCITY	#14	#10	NYLON-WHITE, BLACK
/HVHAT1	#10 HIGH VELOCITY	#14	#10	NYLON-WHITE, BLACK

Our Trucks Deliver Throughout SE & SW Florida

To Place an Order Please Call Customer Service at 1-800-226-5555 or Fax to 800-582-6110

## Combo Truss Machine Screws



- Typically used for Direct Mount.
- Made from 18-8 passivated stainless steel

**Applications:** Install into a 1/4-20 anchor, wood bushing or other insert with a #3 Phillips bit.

ITEM NO.	SIZE / MATERIAL
25C50MCTS	1/4-20 X 1/2" 18-8 SS
25C75MCTS	1/4-20 X 3/4" 18-8 SS
25C100MCTS	1/4-20 X 1" 18-8 SS
25C125MCTS	1/4-20 X 1-1/4" 18-8 SS
25C150MCTS	1/4-20 X 1-1/2" 18-8 SS
25C175MCTS	1/4-20 X 1-3/4" 18-8 SS
25C200MCTS	1/4-20 X 2" 18-8 SS
25C250MCTS	1/4-20 X 2-1/2" 18-8 SS
25C300MCTS	1/4-20 X 3" 18-8 SS
25C350MCTS	1/4-20 X 3-1/2" 18-8 SS
25C400MCTS	1/4-20 X 4" 18-8 SS
25C500MCTS	1/4-20 X 5" 18-8 SS
25C600MCTS	1/4-20 X 6" 18-8 SS

## Aluminum Key-Hole Washers



- Commonly used with Combo Truss Machine Screws.
- Please check your product approval for specific uses.

ITEM NO.	DESCRIPTION
/KEY	ALUMINUM WASHER FOR USE WITH A 1/4-20 BOLT

## Combo Anchors

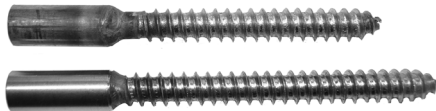

- For use in wood applications.
- Lag length may be cut to order.

ITEM NO.	DESCRIPTION
/37N450LCA3	3/8 X 4-1/2" COMBO WOOD ANCHOR, 316SS COUPLER, 304SS LAG THREAD *
/50N400LCA3	1/2-13 X 4" COMBO WOOD ANCHOR, 316SS COUPLER, 304SS LAG THREAD*

\*Other lengths available by special order.

*Our Trucks Deliver Throughout SE & SW Florida*

To Place an Order Please Call Customer Service at 1-800-226-5555 or Fax to 800-582-6110

**T-Handle Lock Kit**



Please specify color when ordering.  
**Applications:** For use in many shutter systems.  
WH=White IV=Ivory BE=Beige BZ=Bronze

ITEM NO.	AVAILABLE COLORS
/LO_	WHITE, BRONZE, BEIGE, IVORY & CHROME

**HV™ Locks**



All HV Locks come with a  
**Dust Cover!**

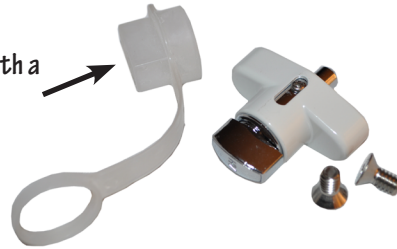

Please specify color when ordering.  
**Applications:** Locks and components used with the High Velocity (HV) system. The thumb turn lock is used for means of egress.

ITEM NO.	AVAILABLE COLORS
/LOHVBE	HV KEY CYLINDER - BEIGE
/LOHVBZ	HV KEY CYLINDER - BRONZE
/LOHVIV	HV KEY CYLINDER - IVORY
/LOHVWH	HV KEY CYLINDER - WHITE
/LOHVTTBR/BE	HV THUMBTURN LOCK - BEIGE
/LOHVTTBR/BZ	HV THUMBTURN LOCK - BRONZE
/LOHVTTBR/IV	HV THUMBTURN LOCK - IVORY
/LOHVTTBR/WH	HV THUMBTURN LOCK - WHITE
/LOHVTT	THUMBTURN CYLINDER ONLY

**CF Lock**



Available in silver finish.  
**Applications:** For use with the centerfold shutter system.

ITEM NO.	AVAILABLE COLORS
/LOPLCF	SILVER FINISH

*Our Trucks Deliver Throughout SE & SW Florida*

To Place an Order Please Call Customer Service at 1-800-226-5555 or Fax to 800-582-6110



## Mortise Locks



ITEM NO.	DESCRIPTION
/LOHRHB	HOOK BOLT MORTISE LOCK SS/BRASS LARGE
/LOBRCL	KEY CLYLINDER SS/BRASS LARGE
/LOBRTT	THUMB TURN CYLINDER SS/BRASS LARGE
/LOHRHB/TTKEY	HOOK BOLT MORTISE LOCK KEY/THUMB TURN BRASS/SS

## Key Cylinder



**ITEM NO.**  
/LOBRCL

## Thumbturn



**ITEM NO.**  
/LOBRTT

## Hook Bolt Lock



**ITEM NO.**  
/LOHRHB

## Small Lock & Key/Thumbturn

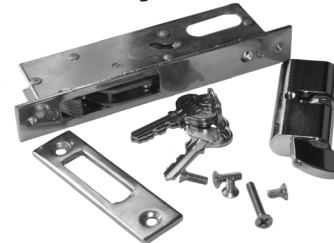

**ITEM NO.**  
/LOHRHB/TTKEY

*Our Trucks Deliver Throughout SE & SW Florida*

To Place an Order Please Call Customer Service at 1-800-226-5555 or Fax to 800-582-6110

## Thumbscrews for Accordion Shutters



Please specify color when ordering.

ITEM NO.	DESCRIPTION
10C75MTPS	10-24 X 3/4 THUMBSCREW 18-8 SS
25C75MTPS	1/4-20 X 3/4 THUMBSCREW 18-8 SS
/25C75MTPKW	1/4-20 X 3/4 THUMBSCREW 18-8 SS W/ WHITE KNOB
/25C75MTPKB	1/4-20 X 3/4 THUMBSCREW 18-8 SS W/ BLACK KNOB
/25C100MTPKW	1/4-20 X 1 THUMBSCREW 18-8 SS W/ WHITE KNOB
/25C100MTPKB	1/4-20 X 1 THUMBSCREW 18-8 SS W/ BLACK KNOB
/31C100MTPKW	5/16-18 X 1 THUMBSCREW 18-8 SS W/ WHITE KNOB
/31C100MTPKB	5/16-18 X 1 THUMBSCREW 18-8 SS W/ BLACK KNOB
10C75MTPS	10-24 X 3/4 THUMBSCREW 18-8SS
25C75MTPS	1/4-20 X 3/4 THUMBSCREW 18-8SS
/25C75MTPKW	1/4-20 X 3/4 THUMBSCREW 18-8SS W/WHITE KNOB
/25C75MTPKB	1/4-20 X 3/4 THUMBSCREWS 18-8SS W/BLACK KNOB

## HV Thumb Screws and Plate



ITEM NO.	DESCRIPTION
37C75MTSN	3/8-16 X 1 NYLON THUMBSCREW WHITE FOR HV ACCORDIAN SHUTTERS
37C75MTSNB	3/8-16 X 1 NYLON THUMBSCREW BLACK FOR HV ACCORDIAN SHUTTERS
/HVPLATE	STAINLESS STEEL PLATE LOCK FOR HV ACCORDIAN SHUTTERS

## Locking Pins

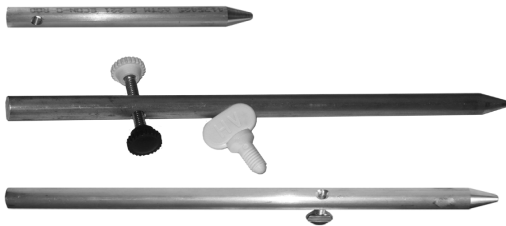

- For use in many shutter systems.
- Custom sizes available.
- We will make locking pins to your exact specifications.

**STANDARD STOCK SIZES INCLUDE:**  
6", 12", 18", 24", 30", & 36", 48", 60", 72", 84", & 96"

Please specify size when ordering.

Please specify plain, white, or black plastic knobs.

**Applications:** Each locking pin comes with one 3/4" Stainless Steel Thumb Screw.  
If ordering HV Locking Pins, please specify 1/4-20 or 3/8-16 Thumb Screw.

ITEM NO.	AVAILABLE COLORS
/LP	1/2" 6061T6 ALUMINUM LOCKING ROD TAPPED WITH A 1/4-20 HOLE
/LPHV	1/2" 6061T6 ALUMINUM LOCKING ROD TAPPED WITH A 3/8-16 HOLE
/LP6/EA	1/2" X 6" LOCKING ROD - HOLE DRILLED 4-1/4" FROM POINT
/LP12/EA	1/2" X 12" LOCKING ROD - HOLE DRILLED 4-1/4" FROM POINT

Our Trucks Deliver Throughout SE & SW Florida

To Place an Order Please Call Customer Service at 1-800-226-5555 or Fax to 800-582-6110

## Accordion Screws

• Please call for information regarding the accordion screw coatings.

• Not all accordion screws are equal. Don't take a chance, order from the experts.



10N200TH84X/LP

10 X 2", HWH #8 HEAD,  
LEAD POINT

410 HT SS, COATED



10N275TUW4/HV

10 X 2-3/4", HWH #8 HEAD  
LEAD POINT

410 HT SS, HV COATED



10N300TH84X/LP

10 X 3", HWH #8 HEAD,  
LEAD POINT

410 HT SS, COATED



14D175TUW4/HV

14 X 1-3/4", HWH #8 HEAD,  
LEAD POINT

410 HT SS, HV COATED



For use with the High Velocity Shutter System. Use with a #10 wheel carriage.

14D275TUW4/HV

14 X 2-3/4", HWH #8 HEAD,  
LEAD POINT

410 HT SS, HV COATED



14D300TUW4/XY

14 X 3", HWH 3/8 HEAD,  
LEAD POINT

410 HT SS, COATED



14D300T124/XY

14 X 3", HWH 5/16 (#12) HEAD,  
LEAD POINT

410 HT SS, COATED



14D300TH84/CO

14 X 3", HWH (#8) HEAD,  
LEAD POINT

410 HT SS, COATED



For use with the Pro Series. Use with a #10 wheel carriage.

14D300TH84/LF/CO

14 X 3", HWH (#8) HEAD,  
LEAD POINT, LARGE FLANGE

410 HT SS, COATED



For use with the many shutter systems. Use with a #10 wheel carriage.

10N250TH8S

10 X 2-1/2", HWH #8 HEAD,  
LEAD POINT

18-8 SS, PASSIVATED

Our Trucks Deliver Throughout SE & SW Florida

To Place an Order Please Call Customer Service at 1-800-226-5555 or Fax to 800-582-6110

## Assembled Parts

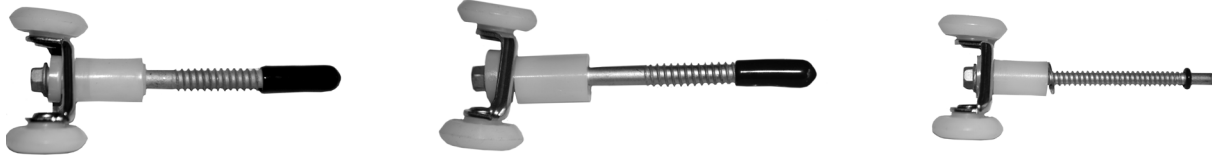

ITEM NO.	DESCRIPTION
/AS-102LGASSY-WH	10X2 SCREW,7/8 NON-RECESSED BUSHING,NO WASHER, WHITE
/AS-102MEDASSY-BL	10 X 2 SCREW, 5/8 BUS RECESSED, C10L WASHER, BLACK
/AS-102MEDASSY-WH	10 X 2 SCREW, 5/8 BUS RECESSED, C10L WASHER, WHITE
/AS-102WAS	10 X 2 SCREW, C10LWASHER, NO BUSHING
/AS-103LGASSY-BL	10 X 3 SCREW, 7/8 BUSHING RECESSED, C10LWASHER, BLACK
/AS-103LGASSY-WH	10 X 3 SCREW, 7/8 BUSHING RECESSED, C10LWASHER, WHITE
/AS-103LGNONASSY-WH	10 X 3 SCREW, 7/8 BUSHING NON-RECESSED, C10LWASHER, WHITE
/AS-103MEDASSY-BL	10 X 3 SCREW, 5/8 BUSHING RECESSED, C10LWASHER, BLACK
/AS-103MEDASSY-WH	10 X 3 SCREW, 5/8 BUSHING RECESSED, C10LWASHER, WHITE
/AS-103WCASSY-BL	10 X 3 SCREW, #10 WHEEL CARRIAGE, #10 HAT BUSHING, 5/8 RECESSED BUSHING, C10LWASHER, BLACK
/AS-103WCASSY-WH	10 X 3 SCREW, #10 WHEEL CARRIAGE, #10 HAT BUSHING, 5/8 RECESSED BUSHING, C10LWASHER, WHITE
/AS-10N3WAS	10 X 3 SCREW, C10LWASHER, NO BUSHING
/AS-141262-WH	14 X 3 SCREW, 5/16" HD, 5/8 BUSHING RECESSED, C416 WASHER, WHITE
/AS-141262ASSY-WH	14 X 3 SCREW, 5/16" HD, #14 WHEEL CARRIAGE, 5/8 BUSHING RECESSED, C416 WASHER, WHITE
/AS-141275ASSY	14 X 3 SCREW, 5/16" HD, #14 WHEEL CARRIAGE, 3/4 BUSHING, C416 WASHER, WHITE
/AS-141275WCASSY	14 X 3 SCREW, 5/16" HD, #14 WHEEL CARRIAGE, #14 HAT BUSHING, 3/4 BUSHING, C416 WASHER, WHITE
/AS-141287-WH	14 X 3 SCREW, 5/16 HD, 7/8 BUSHING, C416 WASHER, WHITE
/AS-141287ASSY-WH	14 X 3 SCREW, 5/16" HD, #14 WHEEL CARRIAGE, 7/8 BUSHING, C416 WASHER, WHITE
/AS-1412WA	14 X 3 SCREW, 5/16 HD, C416 WASHER, NO BUSHING
/AS-143762-WH	14 X 3 SCREW, 3/8" HD, 5/8 BUSHING, C416 WASHER, WHITE
/AS-143762ASSY-BL	14 X 3 SCREW, 3/8" HD, #14 WHEEL CARRIAGE, 5/8 BUSHING, #14 HAT BUSHING, C416 WASHER, BLACK
/AS-143762ASSY-WH	14 X 3 SCREW, 3/8" HD, #14 WHEEL CARRIAGE, 5/8 BUSHING, #14 HAT BUSHING, C416 WASHER, WHITE
/AS-143787-WH	14 X 3 SCREW, 3/8" HD, 7/8 BUSHING, C416 WASHER, WHITE
/AS-143787ASSY-BL	14 X 3 SCREW, 3/8" HD, #14 WHEEL CARRIAGE, 7/8 BUSHING, C416 WASHER, BLACK
/AS-143787ASSY-WH	14 X 3 SCREW, 3/8" HD, #14 WHEEL CARRIAGE, 7/8 BUSHING, C416 WASHER, WHITE
/AS-1437WA	14 X 3 SCREW, 3/8" HD, C416 WASHER, NO BUSHING
/AS-1450ASSY-BL	14 X 3 SCREW, 1/4" HD, 1/2" BUSHING, BLACK
/AS-1450ASSY-WH	14 X 3 SCREW, 1/4" HD, 1/2" BUSHING, WHITE
/AS-1450ASSYW-BL	14 X 3 SCREW, 1/4" HD, 1/2" BUSHING, C416 WASHER, BLACK
/AS-1450ASSYW-WH	14 X 3 SCREW, 1/4" HD, 1/2" BUSHING, C416 WASHER, WHITE
/AS-1487ASSY-BL	14 X 3 SCREW, 1/4" HD, 7/8" BUSHING, BLACK
/AS-1487ASSY-WH	14 X 3 SCREW, 1/4" HD, 7/8" BUSHING, WHITE
/AS-1487ASSYW-BL	14 X 3 SCREW, 1/4" HD, 7/8" BUSHING, C416 WASHER, BLACK
/AS-1487ASSYW-WH	14 X 3 SCREW, 1/4" HD, 7/8" BUSHING, C416 WASHER, WHITE
/AS-14WASH	14 X 3 SCREW, 1/4" HD, C416 WASHER, NO BUSHING
/AS-14WCASSY-BL	14 X 3 SCREW, 1/4" HD, #14 WHEEL CARRIAGE, #14 HAT BUSHING, 3/4" BUSHING, BLACK
/AS-14WCASSY-WH	14 X 3 SCREW, 1/4" HD, #14 WHEEL CARRIAGE, #14 HAT BUSHING, 3/4" BUSHING, WHITE
/AS-14WCASSYW-BL	14 X 3 SCREW, 1/4" HD, #14 WHEEL CARRIAGE, #14 HAT BUSHING, 3/4" BUSHING, C416 WASHER, BLACK
/AS-14WCASSYW-WH	14 X 3 SCREW, 1/4" HD, #14 WHEEL CARRIAGE, #14 HAT BUSHING, 3/4" BUSHING, C416 WASHER, WHITE
/AS-HV14LGASSY-BL	14 X 2 3/4 HV SCREW,HV LONG BUSHING, BLACK
/AS-HV14LGASSY-WH	14 X 2 3/4 HV SCREW, HV LONG BUSHING, WHITE
/AS-HV14SHASSY-BL	14 X 2-3/4 HV SCREW HV SHORT BUSHING, BLACK
/AS-HV14SHASSY-WH	14 X 2-3/4 HV SCREW HV SHORT BUSHING, WHITE
/AS-HV14WCASSY-BL	14 X 2 3/4 HV SCREW, #10 WHEEL CARRIAGE, HV HAT BUSHING, HV SHORT BUSHING, BLACK
/AS-HV14WCASSY-WH	14 X 2 3/4 HV SCREW, #10 WHEEL CARRIAGE, HV HAT BUSHING, HV SHORT BUSHING, WHITE
/AS-HV3LGASSY-BL	10 X 3 SCREW, HV LONG BUSHING, C10L WASHER, BLACK

*Our Trucks Deliver Throughout SE & SW Florida*

**To Place an Order Please Call Customer Service at 1-800-226-5555 or Fax to 800-582-6110**

We carry an extensive line of Hurricane Hardware. If you need an item and don't see it in our catalog, we would be happy to find it for you. *Special orders are never a problem at All Points!*

## Assembled Parts, cont.



ITEM NO.	DESCRIPTION
/AS-HV3LGASSY-WH	10 X 3 SCREW, HV LONG BUSHING, C10L WASHER, WHITE
/AS-HV3MEDASSY-BL	10 X 3 SCREW, HV SHORT BUSHING, C10L WASHER, BLACK
/AS-HV3MEDASSY-WH	10 X 3 SCREW, HV SHORT BUSHING, C10L WASHER, WHITE
/AS-HV3WACASSY-BH	10 X 3 SCREW, HV SHORT BUSHING, HV HAT BUSHING, C10L WASHER, BLACK
/AS-HV3WACASSY-WH	10 X 3 SCREW, HV SHORT BUSHING, HV HAT BUSHING, C10L WASHER, WHITE
/AS-HVLGASSY-BL	14 X 2 3/4 HV SCREW, HV LONG BUSHING, WHITE
/AS-US14LGASSY-WH	US. ALUM, 14X3 SCREW, LARGE FLANGE, LONG BUSHING, WHITE
/AS-US14SHASSY-WH	US. ALUM, 14X3 SCREW, LARGE FLANGE, SHORT BUSHING, WHITE
/AS-US14WCASSY-WH	US. ALUM, 14X3 SCREW, LARGE FLANGE, #10 WHEEL CARRIAGE, MEDIUM BUSHING, HAT BUSHING, WHITE

## Tapered Driver for Accordion Screws



ITEM NO.	DESCRIPTION
/25DHT	DRIVER FOR #8 HEAD ACCORDION SCREWS

## Wheel Carriages



- Our wheel gages feature a one piece design with an 18-8 SS rivet.
- **NOT all carriages are equal!!**

**Applications:** For use in Accordion Shutter Systems.  
Wheel carriage fits many shutter systems, such as the Eastern Metal, Town & Country, Centerfold Accordions, and Pro Series I. Our standard WC10 wheel carriage has a stainless steel carriage and stainless steel rivets.

ITEM NO.	DESCRIPTION
/WC10	STAINLESS STEEL, NYLON ROLLERS
/WC14	STAINLESS STEEL, NYLON ROLLERS

## Washers



**Applications:** The following sizes are commonly used to assemble accordions.  
Please ask your sales representative for alternate washer options.

ITEM NO.	DESCRIPTION	MATERIAL / FINISHES
10NWSFS	#10 X 7/16", 18-8 SS	.062 THK #10 SCREWS
/10NWSFC10LS	#10 X 7/16", 18-8 SS	.032 THK #10 SCREWS (THINNER VERSION)
25NWF5	#14 X 5/8", 18-8 SS	.050 THK #14 SCREWS
/25N50WSFS416	#14 X 1/2", 18-8 SS	.062 THK #14 SCREWS
/25N50WSFS416L	#14 X 1/2", 18-8 SS	.032 THK #14 SCREWS (THINNER VERSION)

*Our Trucks Deliver Throughout SE & SW Florida*

To Place an Order Please Call Customer Service at 1-800-226-5555 or Fax to 800-582-6110

We carry an extensive line of Hurricane Hardware. If you need an item and don't see it in our catalog, we would be happy to find it for you. *Special orders are never a problem at All Points!*

**Tapcon SG™**

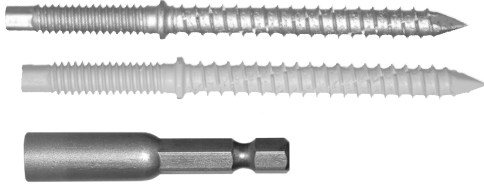

- The Tapcon SG is a high performance anchor for direct mount of panels to wood, hollow block, and concrete.
- Self-tapping in wood.
- Use a 3/16" drill bit to pre-drill in hollow block and a .234 drill bit in concrete.



ITEM NO.	DESCRIPTION	MATERIAL / FINISHES
25N225TSG/—	14 X 2-1/4"	CARBON STEEL W/ ULTRASHIELD, SILVER OR WHITE
25N325TSG/—	14 X 3-1/4"	CARBON STEEL W/ ULTRASHIELD, SILVER OR WHITE
/18NSG	3/16"	DRIVER FOR THE TAPCON SG
/18NSGI	3/16"	DRIVER FOR THE TAPCON SG, ECONOMY VERSION

**Sammys®** by ITW Buildex

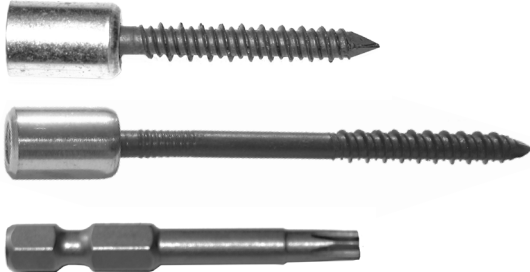

- Body of a Tapcon® with an internally threaded 18-8 Stainless Steel head.



ITEM NO.	DESCRIPTION	MATERIAL / FINISHES
/SSS25C125	1-1/4"	TAPCON with 1/4-20 SS CAP
/SSS25C175	1-3/4"	TAPCON with 1/4-20 SS CAP
/SSS25C225	2-1/4"	TAPCON with 1/4-20 SS CAP
/SSS25C275	2-3/4"	TAPCON with 1/4-20 SS CAP
/SSS25C325	3-1/4"	TAPCON with 1/4-20 SS CAP
/SSS25C375	3-3/4"	TAPCON with 1/4-20 SS CAP
/SSS25C400	4"	TAPCON with 1/4-20 SS CAP
/SSS25C500	5"	TAPCON with 1/4-20 SS CAP
/SSS25C600	6"	TAPCON with 1/4-20 SS CAP
/SSST-25BIT	T-25 X 1-15/16"	TORX DRIVER BIT FOR THE SAMMY SUPER SCREW
/SSSSW	1/4 X 2", 1/4-20 CAP	SS FOR USE IN WOOD
/SSSSW-3	1/4 X 3", 1/4-20 CAP	SS FOR USE IN WOOD
/POWERBITW		SLOT DRIVER FOR WOOD ANCHOR

*Our Trucks Deliver Throughout SE & SW Florida*

To Place an Order Please Call Customer Service at 1-800-226-5555 or Fax to 800-582-6110

## Panelmate® Anchors

Female Panelmates are measured by overall length. Panelmate Pro measured by length under washer.

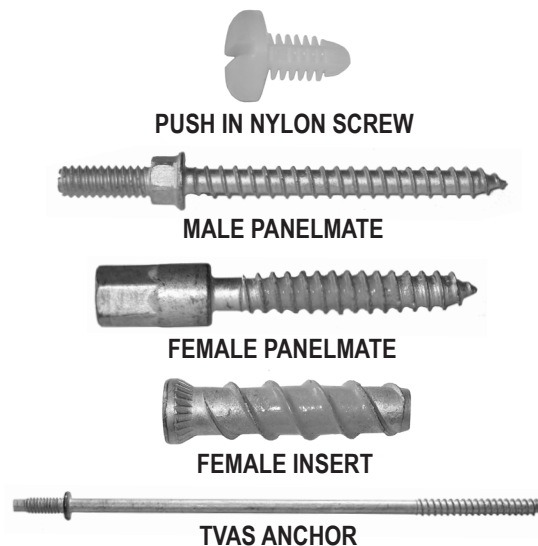
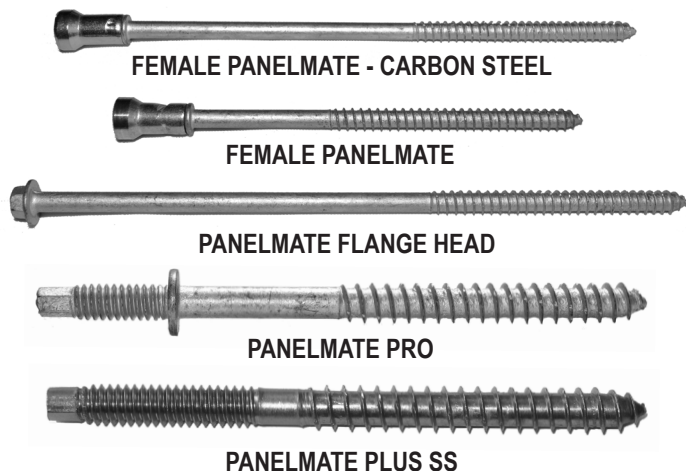

ITEM NO.	DESCRIPTION	MATERIAL / FINISHES
25N175TFP	14 X 1-3/4" FEMALE PANELMATE	STEEL, SILVER STALGARD COATED
/25N262TFPS	14 X 2-5/8" FEMALE PANELMATE	STAINLESS STEEL
/25N325TFP	14 X 3-1/4" FEMALE PANELMATE	STEEL, SILVER STALGARD COATED, STAINLESS STEEL
/25N450TFP	14 X 4-1/2" FEMALE PANELMATE	STEEL, SILVER STALGARD COATED, STAINLESS STEEL
/25N550TFP	14 X 5-1/2" FEMALE PANELMATE	STEEL, SILVER STALGARD COATED, STAINLESS STEEL
/FEMALE PANELMATE IN	1/2 X 2-1/8" INSERT, 5/16" DRIVE	STEEL, SILVER STALGARD COATED,
/FEMALE SHORT	1/2 X 1-3/8" INSERT, 5/16" DRIVE	STEEL, SILVER STALGUARD COATED
/25N343TMPS	14 X 3-7/16" PANELMATE PLUS, SILVER	STAINLESS STEEL
/24N225TMPP	14 X 2-1/4" PANELMATE PRO, 7/8" HEX STUD	STEEL, SILVER STALGUARD COATED
/25N225TMPP/118	14 X 2-1/4" PANELMATE PRO, 1-1/8" HEX STUD	STEEL, SILVER STALGUARD COATED, STAINLESS STEEL
/25N325TMPP	14 X 3-1/4" PANELMATE PRO	STEEL, SILVER STALGUARD COATED, STAINLESS STEEL
/25N325TMPP/118	14 X 3-1/4" PANELMATE PRO, 1-1/8" HEX STUD	STEEL, SILVER STALGUARD COATED, STAINLESS STEEL
/25N450TMPP/118	14 X 4-1/2" PANELMATE PRO, 1-1/8" HEX STUD	STEEL, SILVER STALGUARD COATED, STAINLESS STEEL
/25N550TMP/118	14 X 5-1/2" PANELMATE PRO, 1-1/8" HEX STUD	STEEL, SILVER STALGUARD COATED, STAINLESS STEEL
/25N737TMP	14 X 7-3/8" MALE PANELMATE	STEEL, SILVER STALGUARD COATED, STAINLESS STEEL
/25N737TMPFH/NS	14 X 7-3/8" HEX FLANGE NO STUD	STEEL, SILVER, STALGUARD COATED
/PUSH IN SCREW NYL	1/4" PLUG	NYLON

*Our Trucks Deliver Throughout SE & SW Florida*

To Place an Order Please Call Customer Service at 1-800-226-5555 or Fax to 800-582-6110

**Accessories / Installation Tools for Panelmate® Products**



**3/16" DRIVE SOCKET FOR  
PANELMATE PRO SERIES**

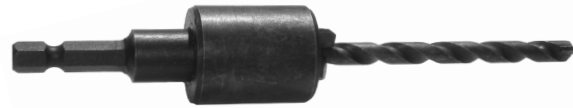

**PANELMATE COMBO BIT  
(to countersink Male/Female panelmates)**



**3/8" DEEP SOCKET DRIVER  
(for use with Male and  
Female Panelmate)**



**7/32 DRILL BITS**

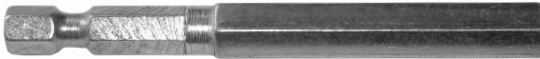

**FEMALE INSERT DRIVER**



**PANELMATE REPLACEMENT BIT**

**Applications:** Panelmate combination drill bits drill a 7/32 pilot hole for the Male and Female Panelmates and countersinks the hex nut on the Male and the head on the Female. The bit is set to countersink the Male Panelmate. Reverse the collar to set the Female Panelmate.

ITEM NO.	MATERIALS / DESCRIPTION
/PANELMATECOMBOBIT-DOM	PANELMATE COMBINATION DRILL BIT
/PANELMATE COMBO BIT E	PANELMATE COMBINATION DRILL BIT-ECONOMY SILVER
/ELCOPRB	7/32 X 4" PANELMATE REPLACEMENT BIT
/ELCO3/16 DRIVER	3/16" DRIVE SOCKET FOR PANELMATE PRO OR PANELMATE PLUS
/118CAP	1-1/8" PLASTIC CAP WHITE OR BRONZE
/37R400DSD	3/8" DEEP SOCKET DRIVER - GENERIC
21R1200DSD	7/32 X 12" SDS DRILL BIT
21R550DSD/HX/ELCO	7/32 X 5-1/2" SDS DRILL BIT HEX SHANK
21R600DSD	7/32 X 6" SDS DRILL BIT
21R800DSD	7/32 X 8" SDS DRILL BIT
21R1100DSD	7/32 X 11 SDS DRILL BIT
21R600DBM	7/32 X 6" MASONRY DRILL BIT
21R400DBM	7/32 X 4" MASONRY DRILL BIT
21R1200DBM	7/32 X 12" MASONRY DRILL BIT
/FEMALE INS DRIVER	FEMALE INSERT HEX DRIVER 5/16"

*Our Trucks Deliver Throughout SE & SW Florida*

**To Place an Order Please Call Customer Service at 1-800-226-5555 or Fax to 800-582-6110**



## Jack-Nuts and Jack-Nut Tools



- Jack nuts are available in steel and brass, nickel plated.
- Hydraulic tools available by special order.

ITEM NO.	SIZE / MATERIAL / DESCRIPTION
/25CJACKB	1/4-20 JACKNUT - BRASS, NICKEL PLATED
/25CJACKSZ	1/4-20 JACKNUT - ZINC PLATED - SHORT - 1/4-20 x 5/8"
/25CJACKL	1/4-20 JACKNUT - ZINC PLATED - LONG - 1/4-20 x 3/4"
/JACKNUTTOOL	HAND INSTALLATION TOOL TO SET JACKNUTS
/25ROD	*1/4-20 ROD FOR THE JACKNUT TOOL (MUST BE ORDERED SEPERATELY)

## Rivet Nuts & Rivet Nut Tools



- Hydraulic tools available by special order.

**Applications:** Flat aluminum rivet nuts place threads into thin metal. Hand rivet tool installs the aluminum rivet nut. 1/4-20 mandrel is for use with the hand rivet nut tool.

ITEM NO.	SIZE / MATERIAL / DESCRIPTION
/25CRFNA	1/4-20 X 5/8" - FLAT, ALUMINUM
/25CRFNA/MED	1/4-20 X 11/16" - FLAT, ALUMINUM
/25CRFNA/LONG	1/4-20 X 3/4" - FLAT, ALUMINUM
/39300	HAND RIVETNUT TOOL
/25CMANDREL	*1/4-20 ROD FOR USE WITH THE HAND TOOL

## Speed Nuts



- Used to hold machine screws in place for stitching panels.

ITEM NO.	SIZE / MATERIAL / DESCRIPTION
/25CNTSP	1/4-20 SPEED NUT BLACK PHOSPATE

Our Trucks Deliver Throughout SE & SW Florida

To Place an Order Please Call Customer Service at 1-800-226-5555 or Fax to 800-582-6110

## Hex Lags



- Head painting available.
- Full hex lag listing on pages 41 -42.
- Full thread available in some sizes.

\* Please specify material in first space provided. Specify finish in spaces proceeding if applicable.  
BH = Bronze Head WH = White Head S=18-8 300 Series Stainless Steel HDG = Hot Dipped Galvanized Z = Zinc Plated

**Applications:** The following are sizes commonly used in shutter applications.

Please see our Hex Lag section of the catalog for a more complete listing. Fully threaded hex lags are available

ITEM NO.	SIZE	MATERIAL / FINISHES
*25N50BLG_	1/4 X 1/2"	ZINC PLATED, HDG, 18-8 SS
*25N100BLG_	1/4 X 1"	ZINC PLATED, HDG, 18-8 SS
*25N150BLG_	1/4 X 1-1/2"	ZINC PLATED, HDG, 18-8 SS
*25N200BLG_	1/4 X 2"	ZINC PLATED, HDG, 18-8 SS
*25N250BLG_	1/4 X 2-1/2"	ZINC PLATED, HDG, 18-8 SS,
*25N300BLG_	1/4 X 3"	ZINC PLATED, HDG, 18-8 SS
*25N350BLG_	1/4 X 3-1/2"	ZINC PLATED, HDG, 18-8 SS
*25N400BLG_	1/4 X 4"	ZINC PLATED, HDG, 18-8 SS
*25N450BLG_	1/4 X 4-1/2"	ZINC PLATED, HDG, 18-8 SS
*25N500BLG_	1/4 X 5"	ZINC PLATED, HDG, 18-8 SS
*25N550BLG_	1/4 X 5-1/2"	ZINC PLATED, HDG, 18-8 SS
*25N600BLG_	1/4 X 6"	ZINC PLATED, HDG, 18-8 SS

*Don't forget to order your 7/16" driver!*

## End Retention Screws

*For the Eastern Metal Shutter System*

ITEM NO.	DESCRIPTION	MATERIAL / FINISHES
*10N250UQL4/CO	10 X 2-1/2"	END RETENTION SCREWS FOR 58MM

## Teks® and Self-Drill Screws



Please see our Tek® / Self Drill section for a larger selection. The following are popular Self-Drill sizes & finishes for the Shutter Industry.

SIZE	DESCRIPTION	MATERIAL / FINISHES
10 X 3/4" HWH	18-8 SS, 410 SS, STEEL, ZINC PLATED	WH, BZ, IV, BE, HEAD & COATED
10 X 1" HWH	410 SS, STEEL, ZINC PLATED	WHITE & BRONZE
10 X 1-1/2" HWH	410 SS, STEEL, ZINC PLATED	WHITE & BRONZE
10 X 2" HWH	410 SS, STEEL, ZINC PLATED	WHITE & BRONZE
12 X 3/4" HWH	410 SS, STEEL, ZINC PLATED	WH, BZ, IV, BE, HEAD & COATED
14 X 3/4" HWH	18-8 SS, 410 SS, STEEL, ZINC PLATED	WH, BZ, IV, BE, HEAD & COATED
1/4 X 1" HWH	18-8 SS, 410 SS, STEEL, ZINC PLATED	WHITE & BRONZE

*We stock 410SS 18 SS painted self drills.*

*Our Trucks Deliver Throughout SE & SW Florida*

To Place an Order Please Call Customer Service at 1-800-226-5555 or Fax to 800-582-6110

## Hammer Drive Anchors



- Name brands available.
- Zamac body.
- Nails available in stainless steel.
- Offers more security than concrete screws. Not easily removed.

\* Please specify material in space provided.  
S=18-8 300 Series Stainless Steel      Z = Zinc Plated  
**Applications:** Use in concrete and concrete block.

ITEM NO.	MATERIALS / DESCRIPTION
*25N75AHD_	1/4 X 3/4" - ZAMAC, STAINLESS STEEL
*25N100AHD_	1/4 X 1" - ZAMAC, STAINLESS STEEL
*25N125AHD_	1/4 X 1-1/4" - ZAMAC, STAINLESS STEEL
*25N150AHD_	1/4 X 1-1/2" - ZAMAC, STAINLESS STEEL
*25N200AHD_	1/4 X 2" - ZAMAC, STAINLESS STEEL

## Paint and Paint Pens



*Ask about our private labeling!*

ITEM NO.	DESCRIPTION	USES
/PAINT-HGWH	HIGH GLOSS WHITE	MATCHES EMS HIGH GLOSS EXTRUSION
/PAINT-HGIV	HIGH GLOSS IVORY	MATCHES EMS HIGH GLOSS EXTRUSION
/PAINT-HGBE	HIGH GLOSS BEIGE	MATCHES EMS HIGH GLOSS EXTRUSION
/PAINT-HGBR	HIGH GLOSS BRONZE	MATCHES EMS HIGH GLOSS EXTRUSION
/PAINTEXWH	EXTRUSION WHITE	A BRIGHT WHITE
/PAINTEXBZ	EXTRUSION BRONZE	SUITABLE FOR MOST BRONZE EXTRUSIONS
/PAINTBB	BRIGHT BRONZE	A BRIGHT BRONZE FOR EXTRUSION
/PAINTEXBE	EXTRUSION BEIGE	SUITABLE FOR MOST BEIGE EXTRUSIONS
/PAINTHITECHWHITE	HI TECH-WHITE	GLOSSY WHITE, MATCHES THE HI-TECH EXTRUSION
/PAINTHITECHBEIGE	HI TECH-BEIGE	MATCHES THE HI TECH BEIGE EXTRUSION
/PAINTEXIV	EXTRUSION IVORY	SUITABLE FOR MOST IVORY/ALMOND EXTRUSIONS
/PAINT-PENBB	BRIGHT BRONZE	A BRIGHT BRONZE FOR EXTRUSION
/PAINT-PENBE	EXTRUSION BEIGE	SUITABLE FOR MOST BEIGE EXTRUSIONS
/PAINT-PENBZ	EXTRUSION BRONZE	SUITABLE FOR MOST BRONZE EXTRUSIONS
/PAINT-PENEXWH	EXTRUSION WHITE	A BRIGHT WHITE
/PAINT-PENIV	EXTRUSION IVORY	SUITABLE FOR MOST IVORY/ALMOND EXTRUSIONS
/PAINT-PENWH	WHITE	WHITE
/PAINT-PENWW	WW WHITE	A BRIGHT WHITE, FOR MANY SCREEN EXTRUSIONS

*Our Trucks Deliver Throughout SE & SW Florida*

To Place an Order Please Call Customer Service at 1-800-226-5555 or Fax to 800-582-6110

**Cleaners and Lubricants**



*Private label available.*

The Shutter Spray is a wonderful lubricant that also helps prevent corrosion. For use on hurricane shutters, tracks, extrusions, as well as many household uses. This spray acts as a barrier between dissimilar metals.

ITEM NO.	DESCRIPTION
/SPRAY	ALL POINTS SHUTTER SPRAY
/WAX	ALL POINTS SHUTTER WAX
/VINYL CLEANER	PLEXIGLASS AND VINYL CLEANER
/COLD SPRAY GALV	GALVANIZED COLD SPRAY
/SA19010	SIMPLE GREEN AEROSOL - 20oz. CAN

**Caulk**



The following are stocked in our warehouse. We can obtain many additional colors, grades, and manufacturer's brand names.

ITEM NO.	MATERIALS / COLORS
/CA-OSI-H2U/BE	#425 BEIGE ACRYLIC URETHANE
/CA-OSI-H2U/BE457	#457 IVORY ACRYLIC URETHANE
/CA-OSI-H2U/BZ	#201 BRONZE ACRYLIC URETHANE
/CA-OSI-H2U/WH	#001 WHITE ACRYLIC URETHANE
/CA-OSI-HM270/BZ	#201 BRONZE SILICONE
/CA-OSI-HM270/CL	#000 CLEAR SILICONE
/CA-OSI-HM270/GR	#509 GREY SILICONE
/CA-OSI-HM270/WH	#001 WHITE SILICONE
/CA-OSIQUAD/AL	#429 ALMOND MULTI POLIMER
/CA-OSIQUAD/BZ	#201 BRONZE MULTI POLIMER
/CA-OSIQUAD/CA	#451 CAMEO MULTI POLIMER
/CA-OSIQUAD/CL	#000 CLEAR MULTI POLIMER
/CA-OSIQUAD/WH	#001 WHITE MULTI POLIMER
/CA-OSISBR/AL	#429 ALMOND WINDOW & SIDING
/CA-OSISBR/BE	#413 BEIGE WINDOW & SIDING
/CA-OSISBR/BZ	#201 BRONZE WINDOW & SIDING
/CA-OSISBR/IV	#447 IVORY WINDOW & SIDING
/CA-OSISBR/WH	#001 WHITE WINDOW & SIDING
/CA-PAP/AL	#712042 ALMOND ALL PURPOSE
/CA-PAP/BZ	#718042 BRONZE ALL PURPOSE
/CA-PAP/CL	#705042 CLEAR ALL PURPOSE
/CA-PAP/WH	#710042 WHITE ALL PURPOSE
/CA-PAS/AL	#625042 ALMOND ACRYLIC SILICONE
/CA-PAS/CL	#622042 CLEAR ACRYLIC SILICONE
/CA-PAS/WH	#620042 WHITE ACRYLIC SILICONE

*Our Trucks Deliver Throughout SE & SW Florida*

**To Place an Order Please Call Customer Service at 1-800-226-5555 or Fax to 800-582-6110**